

partition chromatographic separations, Messrs. G. S. Redin and E. Ewald for *in vivo* testing data, and Drs. G. R. Allen, Jr., and J. S. Webb, and Professor H. E.

Zimmerman for helpful discussions. We also thank Mr. J. F. Poletto for permission to publish the indicated experiment.

Molecular Mechanisms in Nucleic Acid Photochemistry. I. Sensitized Photochemical Splitting of Thymine Dimer

Angelo A. Lamola

Contribution from the Department of Chemistry and the Radiation Laboratory,¹ University of Notre Dame, Notre Dame, Indiana 46556. Received August 23, 1965

Abstract: Several compounds have been shown to be effective as sensitizers for the photochemical splitting of thymine dimer in aqueous solution. In two cases (sodium 2-triphenylenesulfonate and disodium 2,6-naphthalenedisulfonate) it has been demonstrated that the triplet state of the sensitizer is involved. Possible mechanisms are discussed including one which involves "nonvertical" triplet-energy transfer from the sensitizer to thymine dimer. Implications of these findings for the enzyme-sensitized photoreactivation of photodamaged DNA are considered.

Irradiation with ultraviolet light causes dimerization between adjacent thymines in DNA.² The photo-dimerization involves a cycloaddition of the 5,6 double bonds.^{3,4} Irradiation of the thymine dimer

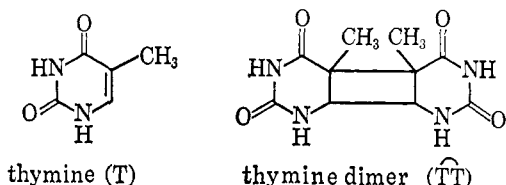

(TT) will lead to efficient splitting, and so a wavelength-dependent, photostationary state can be achieved.⁸ The photostationary ratio lies on the dimer side for wavelengths below about 2600 Å where the dimer begins to absorb (see Figure 1).

Wacker⁷ and later Setlow⁹ demonstrated the presence of thymine dimer in bacteria irradiated with ultraviolet light. However, the first definitive findings involving thymine dimer in biological ultraviolet damage were those reported by the Setlows.¹⁰ They found that

(1) The Radiation Laboratory of the University of Notre Dame is operated under contract with the U. S. Atomic Energy Commission. This is AEC Document No. COO-38-432.

(2) (a) For the most current reviews see K. Smith in "Photophysiology," Vol. II, A. C. Giese, Ed., Academic Press Inc., New York, N. Y., 1964, Chapter 20; (b) A. D. McLaren and D. Shugar, "Photochemistry of Proteins and Nucleic Acids," The Macmillan Co., New York, N. Y., 1964.

(3) D. L. Wulff and G. Fraenkel, *Biochim. Biophys. Acta*, **51**, 332 (1961).

(4) There is very good evidence⁵ that the dimer produced by irradiation of thymine in frozen water solution is a single stereoisomer whose configuration is the *cis-head-to-head*. It has been noted⁶ that this configuration is that which would be expected for the dimer produced in DNA. There is also good evidence that the thymine dimer obtained by irradiation of thymine in ice is the same as that obtained from irradiated DNA.⁷

(5) (a) S. Y. Wang, *Photochem. Photobiol.*, **3**, 395 (1964); (b) G. M. Blackburn and R. J. H. Davies, *Chem. Commun.* (London), 215 (1965).

(6) R. Beukers and W. Berends, *Biochim. Biophys. Acta*, **49**, 181 (1961).

(7) A. Wacker, H. Dellweg, and D. Weinblum, *Naturwissenschaften*, **47**, 477 (1960).

(8) R. B. Setlow, *Biochim. Biophys. Acta*, **49**, 237 (1961).

(9) R. Setlow, R. A. Swenson, and W. L. Carrier, *Science*, **142**, 1464 (1963).

transforming DNA which had been inactivated by irradiation at 2800 Å could be reactivated by subsequent irradiation at 2390 Å. Rupert, *et al.*,^{11,12} found that ultraviolet-inactivated transforming DNA could be reactivated upon treatment with extracts of certain bacteria or baker's yeast in the presence of near-ultraviolet (3000–4000 Å) or even visible light. The phenomenon was shown to involve one or more enzymes. Soon afterwards, Wulff and Rupert¹³ demonstrated that the thymine dimer formed in irradiated DNA *in vitro* could be eliminated by irradiating the DNA in the presence of partially purified photoreactivating enzyme extracted from baker's yeast. Later, the Setlows found an overlap between the enzyme-sensitized reactivation and the 2390-Å reversal of the lesion produced in DNA at 2800 Å. Most recently Setlow and co-workers¹⁴ have been able to correlate the presence of thymine dimer in some synthetic polynucleotides with their ability to compete with irradiated transforming DNA for the photoreactivating enzyme. All this evidence supports the idea that thymine dimer is the major photoreactivable damage in transforming DNA and in some cells.¹⁵

Purpose of the Investigation. The enzyme-sensitized photoreactivation¹⁹ has received much attention,^{20,21}

(10) R. B. Setlow and J. K. Setlow, *Proc. Natl. Acad. Sci. U. S. A.*, **48**, 1250 (1962).

(11) C. S. Rupert, S. H. Goodgal, and R. M. Herriott, *J. Gen. Physiol.*, **41**, 451 (1958).

(12) C. S. Rupert, *ibid.*, **43**, 573 (1960).

(13) D. L. Wulff and C. S. Rupert, *Biochem. Biophys. Res. Commun.*, **7**, 237 (1962).

(14) J. K. Setlow, M. E. Boling, and F. J. Bollum, *Proc. Natl. Acad. Sci. U. S. A.*, **53**, 1430 (1965).

(15) Recently other photoreactivable lesions have been suspected¹⁶ and two have been identified.¹⁷

(16) C. S. Rupert, *Photochem. Photobiol.*, **3**, 399 (1964); J. K. Setlow, *ibid.*, **3**, 405 (1964).

(17) R. B. Setlow, W. L. Carrier, and F. J. Bollum, *Proc. Natl. Acad. Sci. U. S. A.*, **53**, 1111 (1965).

(18) G. N. Lewis and M. Kasha, *J. Am. Chem. Soc.*, **66**, 2108 (1944).

(19) Throughout this paper, it is assumed that the enzyme-sensitized photoreactivation involves the splitting of thymine dimers in the damaged DNA.

(20) C. S. Rupert, ref 2a, p 283, and references therein.

(21) J. Jagger, *Photochem. Photobiol.*, **3**, 451 (1964).

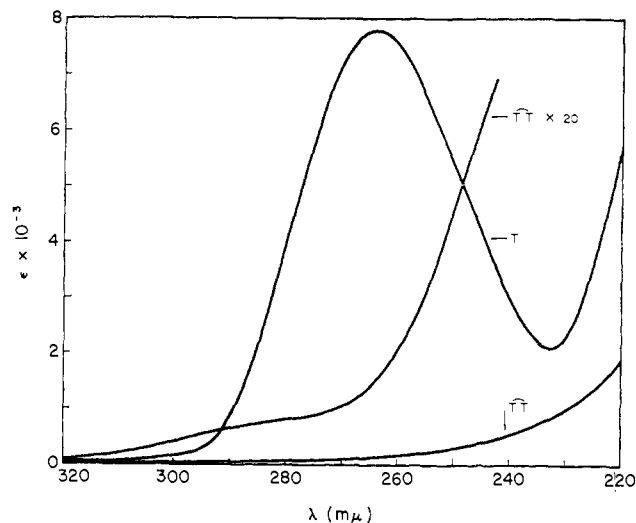

Figure 1. Absorption spectra of thymine and thymine dimer in water at neutral pH.

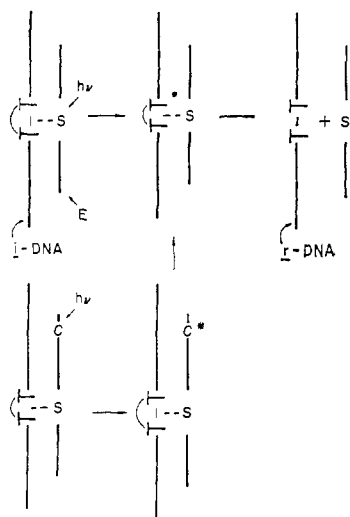

Figure 2. Scheme for the enzyme-sensitized photosplitting of thymine dimer in DNA in which thymine dimer is complexed before light absorption.

and many essential features of the process have been elucidated. At the same time, there remain several important details about which little is known. Rupert²⁰ found that an enzyme-substrate complex, consisting of the photoreactivating enzyme (E) and ultraviolet-damaged DNA (*i*-DNA), is formed. Irradiation of the complex releases the enzyme and reactivated DNA (*r*-DNA). The enzyme does not combine with unirradiated or reactivated DNA. This process has been described in the literature^{20,21} by eq 1. The process exhibits a temperature effect (de-



creasing the temperature lowers the repair rate) and light-intensity saturation.²¹ Although some difficulties arise, both of these effects can be explained on the basis of the complex-forming step.²¹

A possible mechanism for the photolytic step has been suggested.^{20,21} Thymine dimer cannot be split by light of wavelength longer than 3000 Å simply be-

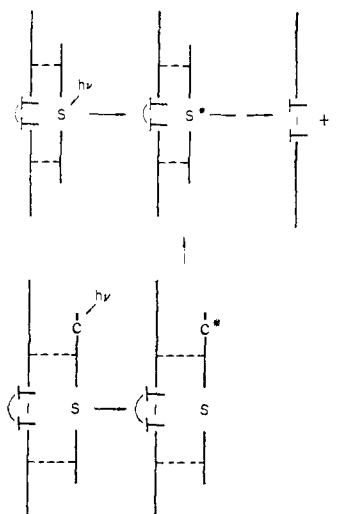

Figure 3. "Energy-transfer" scheme for the enzyme-sensitized photosplitting of thymine dimer in DNA.

cause the dimer does not absorb at these wavelengths. A complex of thymine dimer and the active moiety (S) of the photoreactivating enzyme, however, could well be excited by near-ultraviolet or visible light. The light could be absorbed by the complex or by other chromophores (C) in the enzyme and the excitation transferred to the complex. The excited complex then collapses yielding thymine monomers. This mechanism is diagrammed in Figure 2.

Another class of mechanisms which should be considered is schematically shown in Figure 3. In these mechanisms the thymine dimer is not complexed with the enzyme prior to the photolytic step. Thymine dimer interacts with the active moiety of the enzyme only after it is excited either by direct absorption of the light or by energy transfer after the light is absorbed by some other chromophore in the enzyme. The damaged DNA-enzyme complex in this case assures close approach of thymine dimer and enzyme active site. It was decided to test the feasibility of this kind of mechanism by using a suitable mode. The motive for doing so derived from the several reports²²⁻²⁵ of single bond cleavages effected in several substrates by the action of triplet sensitizers. For the first experiments performed, the thymine dimer obtained by photolyzing thymine in ice was chosen as a model substrate, and several water-soluble compounds which give high yields of triplet states upon excitation were chosen as enzyme models.

Results

Photochemical Experiments. Thymine dimer was prepared by irradiating a frozen water solution of thymine. The dimer was carefully purified and was found to be completely free of monomer. Degassed water solutions (in Pyrex cells) containing 10^{-3} M dimer and various amounts of either 2-triphenylenesulfonic acid sodium salt, 2,6-naphthalenedisulfonic acid disodium salt, or 3-benzophenonesulfonic acid

(22) J. R. Fox and G. S. Hammond, *J. Am. Chem. Soc.*, **86**, 4031 (1964).

(23) G. S. Hammond, P. Wyatt, C. D. DeBoer, and N. J. Turro, *ibid.*, **86**, 2532 (1964).

(24) C. De Boer and G. S. Hammond, in preparation.

(25) C. Walling and M. J. Gibson, *J. Am. Chem. Soc.*, **87**, 3413 (1965).

Table I. Sensitized Splitting of Thymine Dimer^a

Sensitizer	Concn, <i>M</i>	Irradiation time, min	% conversion of \hat{T} to T
None	...	0 ^b	0
	...	583	3
	...	1765	5
2-Triphenylenesulfonic acid sodium salt	0.004	0 ^b	0
	0.004	583	12 ± 2 ^c
	0.004	1765	20 ± 2 ^d
2,6-Naphthalenedisulfonic acid disodium salt	0.003	0 ^b	0
	0.003	583	9 ± 2 ^c
	0.003	1765	16 ± 2 ^d
3-Benzophenonesulfonic acid sodium salt	0.01	0 ^b	0
	0.01	583	0 ^c
	0.01	1765	0 ^c
2-Hydroxymethylnaphtho[2,1- <i>d</i>]imidazole	Satd soln	0 ^b	0
	Satd soln	1765	58
Naphtho[2,1- <i>d</i>]imidazole	Satd soln	0 ^b	0
	Satd soln	1765	67
Eosin	0.001	0 ^b	0
	0.001	583	0
	0.001	1765	0

^a Water solution; 3130-Å excitation; initial concentration of thymine dimer 0.001 *M*; sample size 3.4 cc; 7.2×10^{17} quanta/min absorbed by sensitizer. ^b Stored in dark for a week. ^c Two runs. ^d Three runs.

sodium salt were irradiated using a 450-w medium pressure mercury lamp equipped with a Pyrex filter which cut out the light of wavelengths less than about 3000 Å. The irradiated solutions were analyzed by paper chromatography. A large conversion of the dimer to thymine monomer was observed in the samples containing 2-triphenylenesulfonic acid sodium salt or 2,6-naphthalenedisulfonic acid disodium salt. No thymine was detected in irradiated samples containing no sensitizer or 3-benzophenonesulfonic acid sodium salt. No thymine was detected in mixtures of thymine dimer and the various sensitizers which were kept in the dark for several days.

More quantitative results were obtained by using thymine dimer methyl-¹⁴C and counting the dried chromatograms with a commercial strip scanner. Examples of the tracings obtained are shown in Figure 4. All the results are listed in Table I. In these studies the light was filtered such that most of the light absorbed by the samples was of wavelengths near 3130 Å. Three other sensitizers were examined: eosin, naphtho[2,1-*d*]imidazole (**1a**), and 2-hydroxymethylnaphtho[2,1-*d*]imidazole (**1b**).

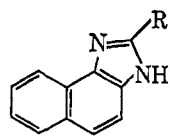

b, R = CH₂OH

The effect of isoprene on the 2-triphenylenesulfonate- and 2,6-naphthalenedisulfonate-sensitized splitting of thymine dimer was examined. These studies were carried out in 50% aqueous ethanol since isoprene is insoluble in water. The results of these experiments are listed in Table II.

Spectroscopic Data. All of the compounds employed as possible sensitizers in this study exhibited phosphorescence in ethylene glycol-water glass (EGW) at 77°K

(the data for eosin was taken from the literature.¹⁸ The triplet excitation energies (0,0 band maxima)

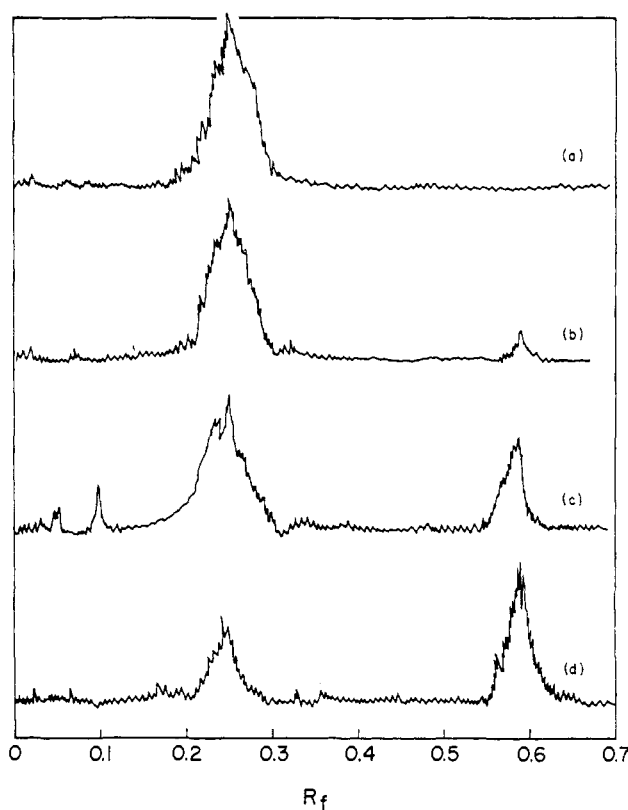

Figure 4. Radiochromatogram tracings: (a) thymine dimer plus sensitizers kept in the dark; (b) irradiated sample containing no sensitizer; (c) irradiated sample containing 2-triphenylenesulfonic acid sodium salt; (d) irradiated sample containing naphtho[2,1-*d*]imidazole. Thymine dimer is at *R_f* 0.25 and thymine at 0.59.

determined from the phosphorescence spectra are listed in Table III.

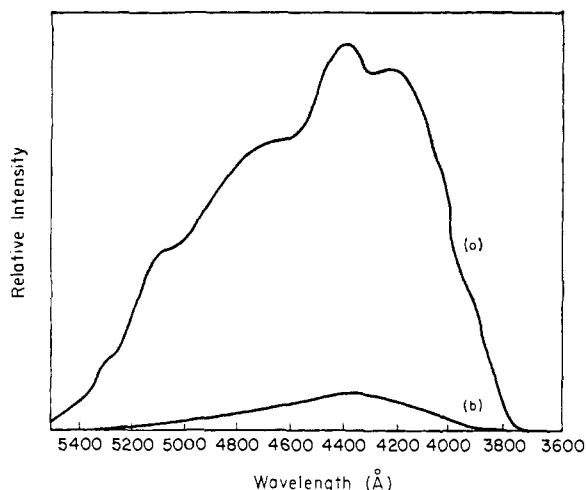

Figure 5. Phosphorescence spectra (samples in EGW at 77°K) of (a) 5,6-dihydrothymine and (b) thymine dimer (shown with ten times the observed relative intensity).

Only a very weak broad phosphorescence could be detected from a sample of thymine dimer in EGW at 77°K (Figure 5b). No estimate of the origin of the spectrum could be made with any certainty because it

Table II. Effect of Isoprene on the Photosplitting of Thymine Dimer^a

Sensitizer	Concn, <i>M</i>	Irradiation time, min	Iso-prene concn, <i>M</i>	% TT to T
2-Triphenylenesulfonic acid sodium salt	0.004	540 ^b	None	9
	0.004	540 ^b	0.05	0
2,6-Naphthalenedisulfonic acid disodium salt	0.003	540 ^b	None	7
	0.003	540 ^b	0.05	0

^a Solvent ethanol-water, 50:50; initial thymine dimer concentration 0.001 *M*; sample size 3.4 cc. ^b 3130-Å excitation; 7.2×10^{17} quanta/min absorbed by sensitizer.

Table III. Triplet Energies of Sensitizers^a

Compound	E_T , kcal/mole
2-Triphenylenesulfonic acid sodium salt	65.0
2,6-Naphthalenedisulfonic acid disodium salt	60.0
3-Benzophenonesulfonic acid sodium salt	70.2
2-Hydroxymethylnaphtho[2,1- <i>d</i>]imidazole	62.5
Naphtho[2,1- <i>d</i>]imidazole	63.3
Eosin	43 ^b

^a Triplet energies refer to the maximum of the 0,0 band of phosphorescence spectra recorded using samples dissolved in an ethylene glycol-water (1:1) glass at 77°K. ^b Value reported by Lewis and Kasha¹⁸ for eosin in EPA at 77°K.

was so weak. A reasonable model for thymine dimer would be 5,6-dihydrothymine. This compound exhibited a moderately strong long-lived phosphorescence in EGW at 77°K (Figure 5a). A triplet energy for 5,6-dihydrothymine of about 73.5 kcal/mole can be estimated from the spectrum.

Discussion

Conclusions. The results (Table I) clearly show that 2-triphenylenesulfonic acid sodium salt, 2,6-naphthal-

enedisulfonic acid disodium salt, naphtho[2,1-*d*]imidazole, and 2-hydroxymethylnaphtho[2,1-*d*]imidazole can sensitize the photosplitting of thymine dimer. Eosin and 3-benzophenonesulfonic acid sodium salt do not sensitize the reaction, and, as a matter of fact, act as photoprotectors under the conditions of these studies. In the irradiated samples containing no sensitizer a small amount of dimer splitting occurred (Table I),²⁶ but in the samples containing 3-benzophenonesulfonic acid sodium salt or eosin, no monomerization was detected.

The energy required to excite isoprene to its lowest-lying planar triplet is about 60 kcal/mole.^{27,28} Thus isoprene should be able to efficiently quench the triplet states of sodium 2-triphenylenesulfonate ($E_T = 65$ kcal/mole) and disodium 2,6-naphthalenedisulfonate ($E_T = 60$ kcal/mole). At the same time, the absorption spectrum of isoprene lies at much higher energy (long wavelength cutoff about 2600 Å) than do the absorption spectra of sodium 2-triphenylenesulfonate and disodium 2,6-naphthalenedisulfonate. And so, isoprene should not be able to quench the lowest excited singlet states of these sensitizers with much efficiency. Vertical transfer of singlet energy from these sensitizers to thymine dimer should not be efficient since the former absorb at higher wavelengths than do the latter. Thus, the totally efficient quenching of the action of sodium 2-triphenylenesulfonate and disodium 2,6-naphthalenedisulfonate strongly implicates the triplet state of these sensitizers in the splitting reaction.

Mechanistic Considerations. Thymine dimer should have a spectroscopic triplet lying a little lower than that of dihydrothymine, the difference in energy depending on the magnitude of the exchange interreaction between the two halves of the thymine dimer. On the basis of the recorded spectra (Figure 5) it is reasonable to say the lowest spectroscopic triplet of thymine dimer lies higher than those of the compounds which are effective in sensitizing the photosplitting of the dimer. Consequently, vertical³⁰ transfer of triplet energy from these sensitizers to thymine dimer would not be possible. An additional indication that the vertical triplet of thymine dimer lies higher than 65 kcal/mole comes from the ineffectiveness of 3-benzophenonesulfonic acid sodium salt as a sensitizer for the splitting reaction. Were the thymine dimer triplet to lie lower by 2 or 3 kcal/mole than that of the 3-benzophenonesulfonate (70.2 kcal/mole), one would expect transfer of triplet excitation from the latter to the former to occur at nearly the diffusion-controlled rate.³² At this rate of transfer one would expect to obtain thymine dimer triplets with nearly unit efficiency even if the lifetime of 3-benzophenonesulfonate triplets were as short as $2 \times$

(26) This is probably due to a small amount of light of wavelengths absorbed by the dimer which is transmitted by the filters. The quantum yield for direct splitting of thymine dimer is nearly unity.¹⁰

(27) D. F. Evans, *J. Chem. Soc.*, 1735 (1960).

(28) This is the excitation energy for the transoid form; the cisoid conformer requires only 53 kcal/mole.²⁹ At room temperature isoprene exists predominantly in its transoid conformation.²⁹

(29) R. S. Liu, N. J. Turro, and G. S. Hammond, *J. Am. Chem. Soc.*, **87**, 3406 (1965).

(30) By a vertical process is meant one which conforms to the Franck-Condon principle. In the case of vertical transfer of triplet energy, the geometry of the acceptor does not change during the transfer process.³¹

(31) J. Saltiel and G. S. Hammond, *J. Am. Chem. Soc.*, **85**, 2515 (1963).

(32) The calculated diffusion-controlled bimolecular rate constant in water at 20° is about 5×10^9 l. mole⁻¹ sec⁻¹.

10^{-7} sec (*vide infra*). Consequently, one might have expected to observe some cleavage of thymine dimer rather than none at all.

Several other documented cases of single bond cleavages caused by interaction of substrate and triplet sensitizer have been reported.^{22-25,33} In all of these cases the spectroscopic (vertical) triplet states of the substrates lie much higher than those of the sensitizers employed. Hammond has proposed a general mechanism for these processes which involves as a key step a "nonvertical" transfer of triplet excitation from the sensitizer to the substrate. The transfer step involves a rather "sticky" collision³⁴ between triplet sensitizer and substrate and leads to inactivated sensitizer and a nonvertical triplet of the acceptor; that is, nuclear motion occurs in the substrate during the transfer process, and the triplet substrate formed has a different geometry from the vibrationally relaxed ground-state substrate. The energy difference between the ground state and the "nonvertical" triplet of the substrate is equal to or less than the triplet energy of the sensitizer. Applying this mechanism to the thymine dimer case, one might describe the situation by eq. 2. In this scheme 2 represents a "nonvertical" triplet state of thymine dimer.

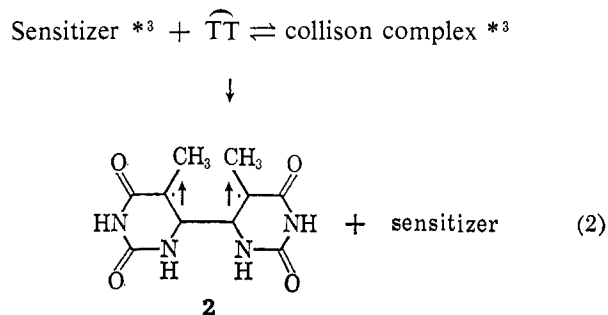

Mechanisms³⁵ which involve covalent bond formation between the sensitizer and substrate at some time during the reaction, although reasonable, do not seem as useful in rationalizing the variable effectiveness of different sensitizers as does the energy-transfer scheme. Too, one might expect to find addition products of sensitizers and substrates. In the thymine dimer case, two compounds (amounting to less than 3% of the total radioactivity) besides thymine and thymine dimer were detected (see Figure 4) when 2-triphenylenesulfonic acid sodium salt was used as the sensitizer. However, no new compounds could be detected in any of the other samples.

In their study of the sensitized isomerization of 1,2-diphenylcyclopropane, Hammond, DeBoer, and Cole^{24,33} have found that the efficiency of the reaction depends on the triplet energy of the sensitizer, the lifetime of the sensitizer triplet, and steric requirements in the collision complex. It is tempting, therefore, to blame the ineffectiveness of triplet eosin in splitting thymine dimer on its relatively low excitation energy. The benzophenone triplet has a lifetime of about 1 μ sec in degassed benzene solution at room temperature³⁶

(33) G. S. Hammond and R. S. Cole, *J. Am. Chem. Soc.*, **87**, 3256 (1965).

(34) The interaction being much greater than that required for vertical triplet-triplet transfer, but not as great as would be required for covalent bond formation between donor and acceptor.³⁵

(35) G. O. Schenck and R. Steinmetz, *Bull. Soc. Chim. Belges*, **71**, 781 (1962).

while those of triphenylene and naphthalene live about 100 times longer.³⁷ If this kind of lifetime difference is true for the corresponding sodium sulfonate derivatives in water solution, then the relative ineffectiveness of sodium 3-benzenesulfonate in splitting thymine dimer might be attributed to the shortness of the lifetime of its triplet. It is interesting to note that triphenylene was reported (22) to be about seven times more effective than benzophenone in another sensitized decomposition reaction thought to involve "nonvertical" triplet energy transfer.

Finally, a mechanism involving energy transfer from a triplet sensitizer to a sensitizer-thymine dimer complex cannot be excluded. However, no evidence for complex formation could be obtained from the absorption spectra of solutions containing thymine dimer and 2-triphenylenesulfonic acid sodium salt, or thymine dimer and 2,6-naphthalenedisulfonic acid disodium salt.

The experiments reported here are not the first attempts to sensitize the photochemical cleavage of thymine dimer. It has been demonstrated³⁸ that irradiation of thymine dimer in aqueous solution in the presence of uranyl acetate with a daylight lamp results in the production of thymine and some unidentified products. The reaction does not occur in the dark. Of special interest is the report that irradiation of

the trinucleoside diphosphate $\widehat{\text{dNpTpT}}$, where N is the naphtho[2,1-*d*]imidazole moiety (1a), with light absorbed by the latter does not lead to splitting of the thymine dimer.³⁸ However, the experiment was run in the presence of air³⁹ so that oxygen could have quenched the naphtho[2,1-*d*]imidazole triplet before it could act upon the dimer.⁴⁰

Enzymatic Photoreactivation. Assuming a mechanism, namely the "nonvertical" energy-transfer mechanism, for the photosplitting of thymine dimer, it is interesting to consider the results obtained in this study with regard to what is known about the enzyme-sensitized photosplitting of thymine dimer in DNA. The ability of irradiated polynucleotides to compete with ultraviolet-irradiated transforming DNA for photoreactivating enzyme has provided much information about the photolesions in the polynucleotides and about the enzyme system itself.^{14,16,17,20} It has been reported^{16,20} that even high concentrations of thymine dimer, thymidine dimer, and the cyclic dinucleotide dimer $\widehat{\text{TpT}}$ did not give observable competitive inhibition of transforming DNA repair. These results would seem to disfavor direct involvement of the thymine dimer moiety in the unexcited damaged DNA-enzyme complex. On the other hand, those features of the ultraviolet-irradiated polynucleotides which are necessary in order to obtain complex formation with the photoreactivating enzyme have not been elucidated. Irradiated apurinic acid and irradiated (pT)₃ do not interact with the enzyme even though thymine dimers

(36) H. L. J. Backstrom and K. Sandros, *Acta. Chem. Scand.*, **14**, 48 (1960).

(37) G. Porter and F. Wilkinson, *Proc. Roy. Soc. (London)*, **A264**, 1 (1961).

(38) A. Wacker, *et al.*, *Photochem. Photobiol.*, **3**, 369 (1964).

(39) A. Wacker, private communication.

(40) Too, possible stringent steric requirements for energy transfer may be difficult to fulfill in $\widehat{\text{dNpTpT}}$.

are present, but all ultraviolet-irradiated natural or synthetic DNA's tested do combine with the enzyme.^{16,20} Furthermore, irradiated poly[d(AT):d(AT)] does not interact with the enzyme¹⁶ whereas the irradiated homopolymer complex dA:dT does interact.¹⁴ The irradiated polynucleotides dI:dC, dG:dC, and dC interact with the enzyme and are photoreactivable, the photoreactivable lesion being cytosine and/or uracil dimers.¹⁴ On the other hand, irradiated RNA or irradiated synthetic polyribonucleotides do not exhibit enzyme-sensitized photoreactivation.

It seems that both *in vivo* and *in vitro* enzyme-sensitized photoreactivations are quite efficient processes.²⁰ A "quantum yield," however, is not easily measured. What might be expected on the basis of the model systems described herein? The quantum yield of thymine dimer splitting using sodium 2-triphenylenesulfonate as sensitizer and 10^{-3} M substrate was found to be about 0.001 (Table I). Assuming that the inefficiency is in the energy-transfer step (the falloff of the rate with time is consistent with this), one would expect the quantum yield to increase with thymine dimer concentration until a limiting quantum yield, controlled by the product of the efficiency of cleavage of the excited thymine dimer and the triplet yield for the sensitizer, is achieved. In a DNA-enzyme complex the "effective" thymine dimer concentration seen by the enzyme active site (sensitizer) would be high and, consequently, the energy-transfer step quite efficient.

Action spectra for photoreactivation have been determined for the *E. coli* B/r system⁴¹ and for the yeast enzyme photoreactivation of transforming DNA.⁴² In both spectra the long wavelength cutoff is near 4200 Å. These spectra are due to the enzyme active site and/or other moieties in the enzyme from which excitation can be transferred to the active site. Taking 5 kcal/mole as a lower limit for the singlet-triplet energy difference, an upper limit for the triplet state energy of the enzyme active site in either system would be 63 kcal/mole. 2,6-Naphthalenedisulfonic acid disodium salt was the lowest energy sensitizer ($E_T = 60$ kcal/mole) successfully employed in the studies described herein. Obviously it would be important to know the low energy limit for the model system and to obtain more information about the photoreactivating enzyme. Since the enzyme combines with irradiated DNA and can be recovered unchanged by irradiation of the complex, it should be possible to obtain small amounts of the pure enzyme, perhaps enough to examine its absorption and emission spectra. Corresponding spectra of the DNA-enzyme complex would also be of interest. Attempts to carry out such a study are underway in these laboratories.

The temperature dependence of enzyme photoreactivation has been attributed to the DNA-enzyme complex formation²¹ since it seems unlikely that the fragmentation of the complex, excited with light of wavelengths of 4000 Å or less (70 kcal/mole or more), would be an activated process. On the other hand, the "nonvertical" energy-transfer mechanism would allow the temperature dependence to be attributed to the

energy-transfer step which would require activation energy.

Experimental Section

Materials. Thymine dimer was prepared according to the procedure described by Wulff and Fraenkel.³ The dimer was twice recrystallized from water and oven dried. No thymine could be detected in the purified dimer by spectrophotometric means.

Thymine dimer methyl-C¹⁴ of specific activity 0.28 μ curie/mg was prepared and purified in the same way as described for the unlabeled dimer. Thymine-methyl-C¹⁴ (28 μ curies/mg) was obtained from the New England Nuclear Co.

2,6-Naphthalenedisulfonic acid sodium salt (Aldrich) was twice recrystallized from water (sodium chloride added) and oven dried.

2-Triphenylenesulfonic acid sodium salt⁴³ was prepared by heating (80°) 1 g of triphenylene (Aldrich) with 3 cc of concentrated sulfuric acid for 0.5 hr. The mixture was poured onto cracked ice and then neutralized with sodium bicarbonate. Sodium chloride was added to precipitate the product which was collected by filtration. The crude product was treated with decolorizing carbon, then recrystallized three times from water (sodium chloride), and finally oven dried. The yield of pure white powder was 320 mg (21%).

3-Benzophenonesulfonic acid sodium salt was prepared according to the procedure reported by Ruggli and Grun.⁴⁴ The compound was purified by repeated recrystallizations from water (sodium chloride added) and was oven dried.

2-Hydroxymethylnaphtho[2,1-d]imidazole, prepared according to Malmberg and Hamilton,⁴⁵ was kindly supplied by Rev. J. L. Walter, C.S.C.

Naphtho[2,1-d]imidazole was generously supplied by Professor A. Wacker. Eosin Y was Eastman certified grade. **Isoprene** (Aldrich) was distilled just prior to use. **5,6-Dihydrothymine** was purchased from the Sigma Chemical Co.

Absorption spectra were recorded with a Cary model recording spectrophotometer or with a Bausch and Lomb Spectronic 505 recording spectrophotometer.

Phosphorescence spectra were recorded photometrically using a Jarrell-Ash 0.5-m Ebert scanning monochromator (f/9) equipped with a 30,000 grooves/in. grating, an EMI 6256 photomultiplier tube, an electrometer amplifier, and a chart recorder. The sample to be studied was contained in a 3-mm quartz tube held in a quartz dewar filled with liquid nitrogen. A "rotating-can" phosphorescope was employed and the emission viewed at right angles to the direction of the exciting light (200-w medium pressure mercury lamp).

Sample Preparation. The apparatus used in the preparation of samples consisted of a Pyrex tube which could be attached to a vacuum line by means of a ground-glass joint. At the end of the tube was a bulb (15-cc capacity). Attached to the tube (just above the bulb) by means of a side arm was a cylindrical Pyrex cell (13-mm o.d.). The solution (3.4 cc) to be irradiated was placed (constant delivery syringe) in the bulb and attached to the vacuum line, the system degassed (to 10^{-4} mm pressure) by the freeze-pump-thaw method (3 cycles), and then the apparatus sealed under vacuum. The degassed solution was then poured from the bulb into the cell which was sealed and removed from the rest of the apparatus. All samples were stored in the dark when not in use.

Irradiation Apparatus. Samples were irradiated in the "merry-go-round" apparatus,⁴⁶ which consists of a circular sample holder (holds up to 30 13-mm sample tubes) which rotates about the light source (Hanovia 450-w medium pressure mercury lamp). The windows through which the samples are irradiated have areas which match to within 0.5%. The light source was surrounded by a cylindrical Pyrex filter (1 mm), a quartz water-cooled jacket, a cylindrical quartz cell (1 cm) containing NiSO₄-CoSO₄ filter solution, and finally Corning C.S.-7-54 color glass filters. This arrangement effectively isolates the group of mercury lines near 3130 Å. The temperature of the samples during irradiation was about 35°.

Benzophenone-benzhydrol actinometry⁴⁷ was employed.

(43) C. C. Barker, *et al.*, *J. Chem. Soc.*, 4482 (1955).

(44) P. Ruggli and F. Crun, *Helv. Chim. Acta*, **24**, 197 (1941).

(45) E. Malmberg and C. Hamilton, *J. Am. Chem. Soc.*, **70**, 2417 (1948).

(46) G. S. Hammond, *et al.*, *ibid.*, **86**, 3197 (1964).

(47) R. P. Foss and G. S. Hammond, *J. Phys. Chem.*, **68**, 3739 (1964).

(41) J. Jagger and R. S. Stafford, *Photochem. Photobiol.*, **1**, 245 (1962).

(42) J. K. Setlow and M. E. Boling, *ibid.*, **2**, 471 (1963).

Analyses. Aliquots (100 μ l which corresponded to about 10^4 dpm in the experiments with labeled thymine dimer) of the solutions were spotted on Whatman No. 1 paper and chromatographed (descending) with 1-butanol-water-acetic acid (80:30:12, v/v/v).⁴⁸ Under these conditions the R_f for thymine dimer is 0.25 and that for thymine is 0.59. Thymine appears as a dark spot when the chromatogram is viewed under ultraviolet light. Thymine dimer can be visually detected after irradiating the dried chromatogram with 2537-Å light which converts dimer to monomer. There was no interference from any of the sensitizers used. The radioactive areas were determined by means of a Vanguard Autoscanner Model 880 (scan speed 12 in./hr, time constant D , counts full scale 300, slit width 0.25 cm). The areas under the tracings were measured with a planimeter.

(48) K. Smith, *Photochem. Photobiol.*, **2**, 503 (1963).

A second chromatographic system employing Whatman No. 1 paper and 2-propanol-concentrated HCl-water (68:15.5:16.5, v/v/v) was also employed. Under these conditions the R_f for thymine dimer is 0.50 and for thymine 0.80.

Acknowledgments. This work was supported in major part by the Radiation Laboratory of the University of Notre Dame which is operated under contract with the U. S. Atomic Energy Commission. Acknowledgment is made to the donors of the Petroleum Research Fund, administered by the American Chemical Society, for partial support of this research (Grant No. 186-G). The author wishes to thank Dr. B. Phillips of the Miles Research Laboratories for recording the radiochromatograms.

Studies on Polynucleotides. LI.¹ Syntheses of the 64 Possible Ribotrinucleotides Derived from the Four Major Ribomononucleotides²

R. Lohrmann, D. Söll, H. Hayatsu, E. Ohtsuka, and H. G. Khorana

Contribution from the Institute for Enzyme Research of the University of Wisconsin, Madison, Wisconsin. Received September 2, 1965

Abstract: The chemical syntheses of all of the possible ribotrinucleotides derivable from the four major mononucleotides have been accomplished using the general approach illustrated in Chart I for the synthesis of guanylyl-(3'→5')cyt'dylyl(3'→5')adenosine I).

Methods for the specific synthesis of ribopolynucleotides containing C_3-C_5' interribonucleotidic linkages have formed the subject of an extended study in this laboratory,³ and the procedures which have emerged have been applied successfully to (a) the stepwise synthesis of a variety of dinucleotides, of several trinucleotides, and of a tetranucleotide and (b) the polymerization of suitably protected ribomononucleotides to yield a series of homologous oligonucleotides.^{3,4} The recent demonstration by Nirenberg and Leder⁵ that ribotrinucleotides can stimulate the binding of specific aminoacyl-t-RNA⁶ to ribosomes has provided a new approach to the deciphering of nucleotide sequences within the trinucleotides which serve as coding units for different amino acids. This discovery and our

own work on the genetic code, which has been reviewed elsewhere,^{7,8} have stimulated us to focus on the preparation of ribotrinucleotides and in the present paper we report on the stepwise synthesis of all of the possible ribotrinucleotides⁹ derived from the four common mononucleotides by general and satisfactory methods.¹⁰ Results of the extensive tests made with these trinucleotides on the stimulation of the binding of the different aminoacyl-t-RNA's⁶ to ribosomes have been described separately.¹¹ Recently, a number of other laboratories have also reported on the preparation of ribotrinucleotides by alternative methods. Thus, Bernfield and Nirenberg,¹² Leder, Singer, and Brimacombe,¹³ Thatch and Doty,¹⁴ and Gilham and co-workers¹⁵

(1) Paper L in this series is by R. D. Wells, E. Ohtsuka, and H. G. Khorana, *J. Mol. Biol.*, **14**, 221 (1965).

(2) This work has been supported by grants from the National Science Foundation (Grant No. GB-3342), the National Cancer Institute of the National Institutes of Health, U. S. Public Health Service (Grant No. CA-05178), the Life Insurance Medical Research Fund (Grant No. G-62-54), and Wisconsin Alumni Research Foundation.

(3) (a) M. Smith, D. H. Rammler, I. H. Goldberg, and H. G. Khorana, *J. Am. Chem. Soc.*, **84**, 430 (1962); (b) D. H. Rammler and H. G. Khorana, *ibid.*, **84**, 3112 (1962); (c) D. H. Rammler, Y. Lapidot, and H. G. Khorana, *ibid.*, **85**, 1989 (1963); (d) Y. Lapidot and H. G. Khorana, *ibid.*, **85**, 3852 (1963); (e) Y. Lapidot and H. G. Khorana, *ibid.*, **85**, 3857 (1963); (f) C. Coutsogeorgopoulos and H. G. Khorana, *ibid.*, **86**, 2926 (1964); (g) R. Lohrmann and H. G. Khorana, *ibid.*, **86**, 4188 (1964); (h) D. Söll and H. G. Khorana, *ibid.*, **87**, 350 (1965); (i) D. Söll and H. G. Khorana, *ibid.*, **87**, 360 (1965).

(4) R. Lohrmann and H. G. Khorana, Abstracts, 145th National Meeting of the American Chemical Society, New York, N. Y., 1963, p 37C.

(5) M. W. Nirenberg and P. Leder, *Science*, **145**, 1399 (1964).

(6) t-RNA is abbreviation for transfer or amino acid acceptor ribonucleic acid.

(7) H. G. Khorana, *Federation Proc.*, **24**, 1473 (1965).

(8) H. G. Khorana, T. M. Jacob, M. W. Moon, S. A. Narang, and E. Ohtsuka, *J. Am. Chem. Soc.*, **87**, 2954 (1965).

(9) The compounds prepared in this paper lack phosphomonoester groups and therefore on the basis of phosphorus content are not strictly "trimers" of mononucleotides. Traditionally they would perhaps be more appropriately described as trinucleoside diphosphates. The latter designation, however, is more ambiguous and less likely to convey the main structural feature of biological interest which is that all these compounds contain three nucleosides in repeating C_3-C_5' internucleotidic linkage. The general name trinucleotide is therefore retained for the present series of compounds.

(10) A brief report of this work has been made in ref 7.

(11) D. Söll, E. Ohtsuka, D. S. Jones, R. Lohrmann, H. Hayatsu, S. Nishimura, and H. G. Khorana, *Proc. Natl. Acad. Sci. U. S.*, **54**, 1378 (1965).

(12) M. Bernfield and M. W. Nirenberg, *Science*, **147**, 479 (1965).

(13) P. Leder, M. F. Singer, and R. L. C. Brimacombe, *Biochemistry*, **4**, 1561 (1965).

(14) R. Thatch and P. Doty, *Science*, **147**, 1310 (1965); **148**, 632 (1965).

(15) J. C. Lee, N. W. Y. Ho, and P. T. Gilham, *Biochim. Biophys. Acta*, **95**, 503 (1965).